

DMG64480K057_03WTR

Features:

- Based on T5L0, running DGUS II system, medical grade products.
- 5.7-inch, 640*480 pixels resolution, 262K colors, IPS-TFT-LCD, wide viewing angle.
- Support RS232 and RS485 communication.
- Resistive touch screen.
- With conformal coating.



1. Hardware and interface

1.1 Hardware interface

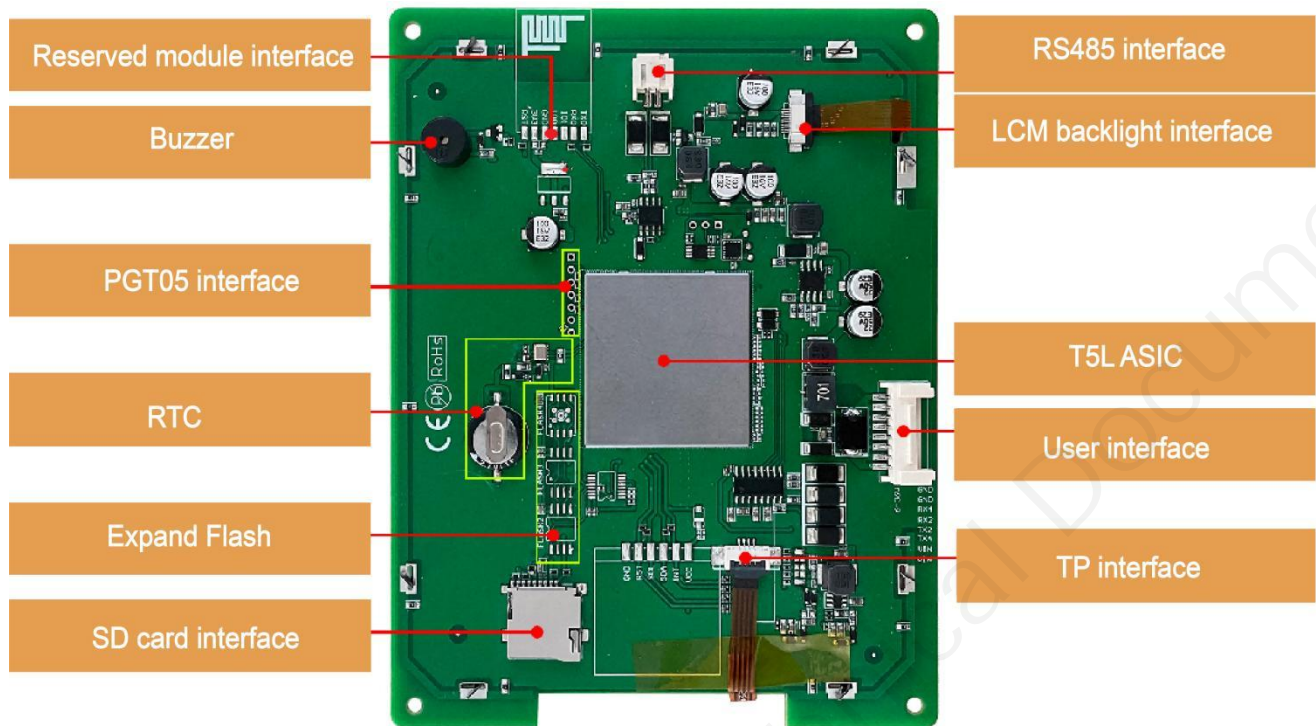

Hardware interface

1.2 Hardware and interface description

No.	Name	Description
1	T5L0 ASIC	Developed by DWIN. Mass production in 2020, 1MBytes Nor Flash on the chip, 512KBytes used to store the user database. Rewrite cycle: over 100,000 times
2	LCM interface	FCC60_0.5mm, RGB interface; FCC10_0.5mm, backlight interface
3	RTP interface	4Pin_1.0mm interface
4	User interface	8Pin_2.0mm socket for power supply and serial communication. Download rate (typical value): 12KByte/s
5	RS485 interface	2Pin_2.0mm horizontal socket: For RS485 communication
6	Flash	16MBytes NOR Flash, for fonts, pictures and audio files. Rewrite cycle: over 100,000 times
7	Expand Flash	Expandable to 64Mbytes NOR Flash or 48Mbytes NOR Flash+512Mbytes NAND Flash
8	Buzzer	3V passive buzzer
9	RTC	Super-capacitor for power supply. Accuracy: $\pm 20\text{ppm}$ @25°C. It can work normally for 7 days after power failure
10	SD card interface	FAT32. Download files by SD interface can be displayed in statistics. Download rate: 4Mb/s
11	Reserved module interface	Wi-Fi module: connect to the cloud platform to update remotely USB module: download files by USB flash disk
12	PGT05 interface	When product crashes by accident, you can use PGT05 to update DGUS kernel and make the product return to normal

2. Specification parameters

2.1 Display parameters

LCD Type	IPS, TFT LCD
Viewing Angle	Wide viewing angle, 85°/85°/85°/85°(L/R/U/D)
Resolution	640×480 pixels (support 0°/90°/180°/270°)
Color	18-bit 6R6G6B
Active Area (A.A.)	115.20mm (W)×86.40mm (H)
Backlight Mode	LED
Backlight Service Life	>30000 hours (Time of the brightness decaying to 50% on the condition of continuous working with the maximum brightness)
Brightness	400nit
Brightness Control	0~100 grade (When the brightness is adjusted to 1%~30% of the maximum brightness, flickering may occur and is not recommended to use in this range)
Note: You can use dynamic screen saver wallpapers to avoid afterimages caused by fixed page display for a long time.	

2.2 Touch parameters

Type	RTP (Resistive touch panel)
Structure	ITO film+ITO glass
Touch Mode	Single point touch, support continuous sliding touch
Surface Hardness	3H
Light Transmittance	Over 80%
Life	Over 1,000,000 times touch

2.3 Serial interface parameters

Mode	UART2: RS232 UART4: RS232 (Only available after OS configuration) UART5: RS485 (Only available after OS configuration)				
UART2,4 Voltage Level (RXD, TXD)	Test Condition	Min	Typ	Max	Unit
	Output 1	-	-5.0	-3.0	V
	Output 0	3.0	5.0	-	V
	Input 1	-15.0	-5.0	-	V
	Input 0	-	5.0	15.0	V
UART2,4 Baud Rate	3150~3225600bps, typical value of 115200bps				
UART5 Voltage Level (V_AB)	Test Condition	Min	Typ	Max	Unit
	Output 1	2.5	5.0	-	V
	Output 0	-	-5.0	-2.5	V
	Input 1	0	2.5	-	V
	Input 0	-	-2.5	-0.2	V
UART5 Baud Rate	3150~921600bps, typical value of 115200bps				
Data Format	UART2: N81 UART4: N81/E81/O81/N82 ,4 modes (OS configuration) UART5: N81/E81/O81/N82 ,4 modes (OS configuration)				
Interface Cable	8Pin_2.0mm (RS232) 2Pin_2.0mm (RS485)				

2.4 Electrical specifications

Rated Power	<5W	
Operating Voltage	6~36V, typical value of 12V	
Operating Current	240mA	VCC=12V, max backlight
	100mA	VCC=12V, backlight off
Recommended power supply: 12V 0.5A DC		

2.5 Operating environment

Operating Temperature	-20℃~70℃ (12V @ 60% RH)
Storage Temperature	-30℃~80℃
Operating Humidity	10%~90%RH, typical value of 60% RH
Conformal coating	Yes
Aging Test	72 hours high temperature charged aging at 50℃

3. Reliability test

3.1 Electrostatic discharge test

Test temperature: 25°C. Test humidity: 50%RH.

Test standard : EN 61000-4-2:2009 IEC 61000-4-2:2008 GB/T 17626.2-2018
 Other:

Table 1: Electrostatic Discharge Immunity (Air Discharge)

Test Points Locations	Test Levels							
	-2kV	+2kV	-4kV	+4kV	-8kV	+8kV	-15kV	+15kV
Screen	/	/	/	/	/	/	A	A
/	/	/	/	/	/	/	/	/
/	/	/	/	/	/	/	/	/

Table 2: Electrostatic Discharge Immunity (Direct Contact)

Test Points Locations	Test Levels							
	-2kV	+2kV	-4kV	+4kV	-6kV	+6kV	-8kV	+8kV
Border	/	/	/	/	/	/	A	A
/	/	/	/	/	/	/	/	/
/	/	/	/	/	/	/	/	/

3.2 EFT test

Test temperature: 25°C. Test humidity: 50%RH.

Test standard : EN 61000-4-4:2012 IEC 61000-4-4:2012 GB/T 17626.4-2018
 Other:

Test Points		Test Levels(kV)							
		-0.5	+0.5	-1.0	+1.0	-2.0	+2.0	-4.0	+4.0
___DC___ Power ports	L	/	/	/	/	A	A	/	/
	N	/	/	/	/	A	A	/	/
	Earth	/	/	/	/	/	/	/	/
	L+N	/	/	/	/	A	A	/	/
	L + Earth	/	/	/	/	/	/	/	/
	N + Earth	/	/	/	/	/	/	/	/
	L+N+Earth	/	/	/	/	/	/	/	/
Signal ports	___/___	/	/	/	/	/	/	/	/

3.3 RE test

Test Item	Test Standard	Result
RE	ClassB-6dB	Normal operation

HORIZONTAL

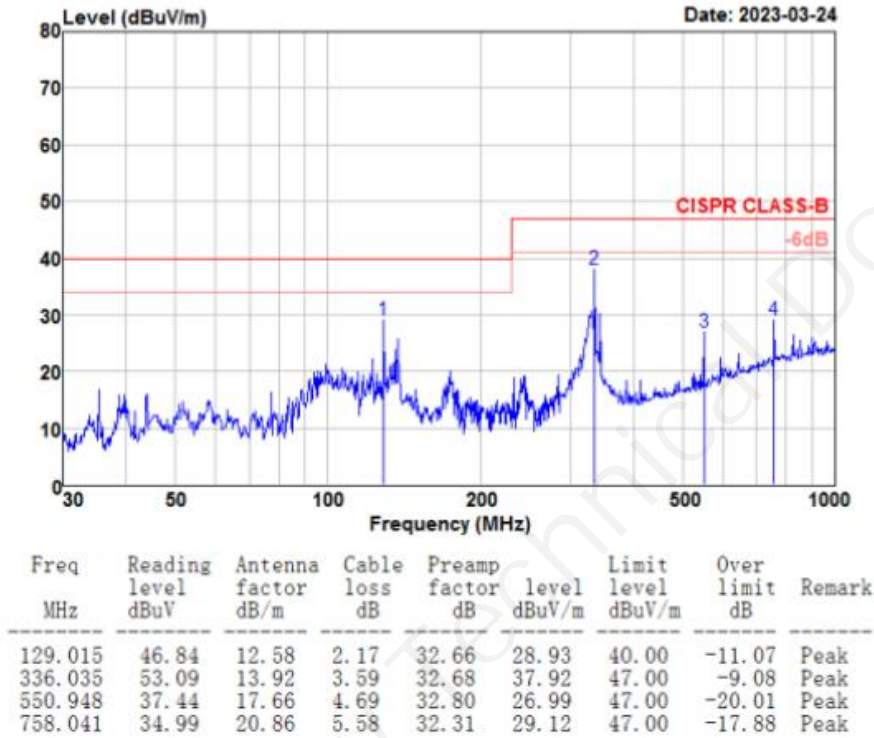

VERTICAL

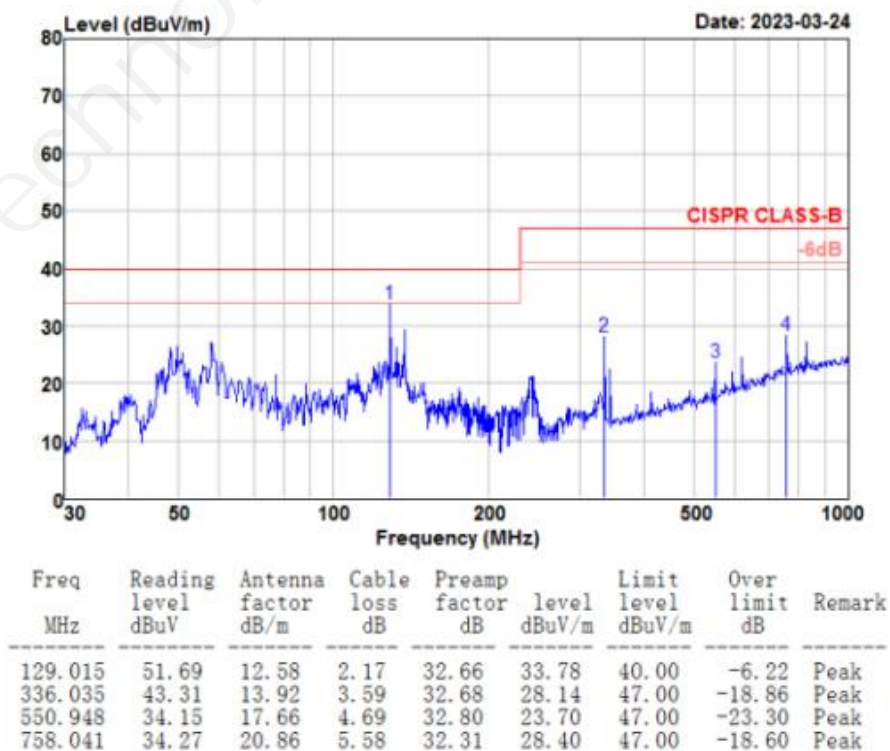

3.4 CS test

- Test standard : EN 61000-4-6:2014 IEC 61000-4-6:2013 GB/T 17626.6-2017
 Other:
- Modulation: Amplitude 80%,1kHz sine wave Amplitude 80%,2Hz sine wave Other:
- Dwell time: 1s 3s other:
- Frequency Step Size : 1 % of preceding frequency value other:

Coupling Line	Frequency Range (MHz)	Voltage Level(e.m.f.) (V)	Result
Power terminal	0.15-80	10	A

3.5 SURGE test

- Test standard : EN 61000-4-5:2014+A1:2017 IEC 61000-4-5:2014+A1:2017 GB/T 17626.5-2019
 Other:

Table 1: _____ mains power input port

Level	Voltage	Polarity	Path	Result
1	0.5kV	±	/	/
2	1kV	±	Positive to negative	A
3	2kV	±	/	/
4	4kV	±	/	/

Performance Criterion:

- A. Normal performance within limits specified by the manufacturer, requestor or purchaser;
- B. Temporary loss of function or degradation of performance which ceases after the disturbance ceases, and from which the equipment under test recovers its normal performance, without operator intervention;
- C. Temporary loss of function or degradation of performance, the correction of which requires operator intervention;
- D. Loss of function or degradation of performance which is not recoverable, due to damage to hardware or software, or loss of data.

4. Packaging & dimensions

Form Factor	144.8mm (W)×110.2mm (H)×18.7mm (T)			
Installation Dimensions	Positioning hole:128.1(+0.3mm)×99.5(+0.3mm)			
Net Weight	-			
Packaging Standards				
Model	Dimensions	Layer	Quantity/Layer	Quantity(Pcs)
Carton1:	220mm(L)×160mm(W)×47mm (H)	1	1	1
Carton2:	250mm(L)×200mm(W)×80mm (H)	2	1	2
Carton3:	320mm(L)×270mm(W)×80mm (H)	2	2	4
Carton4:	450mm(L)×350mm(W)×300mm(H)	2	10	20
Carton5:	600mm(L)×450mm(W)×300mm(H)	2	17	34

Disclaimer: The product design is subject to alternation and improvement without prior notice.

Definition	Pin#	Type	Description
VIN	1, 2	P	Power Input
TX4	3	0	UART4 Output
TX2	4	0	UART2 Output
RX2	5	I	UART2 Input
RX4	6	I	UART4 Input
GND	7, 8	P	GND

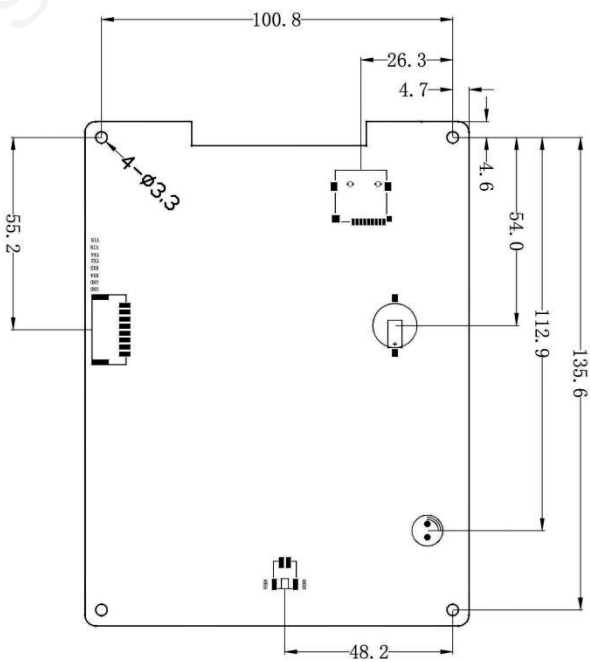
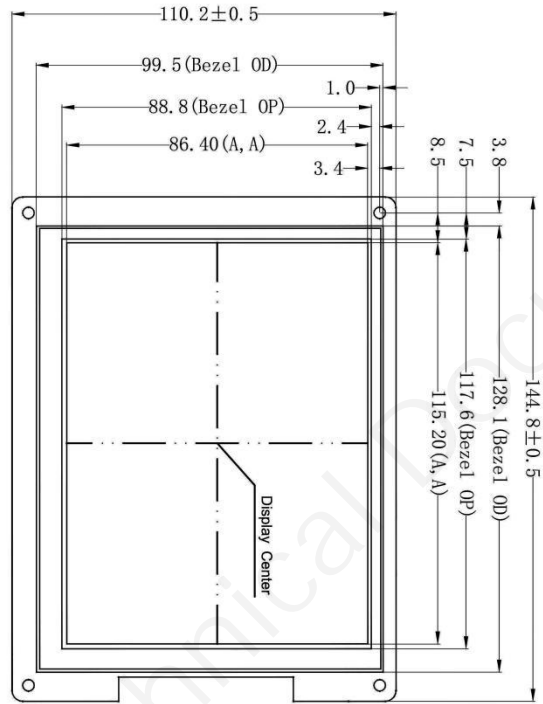
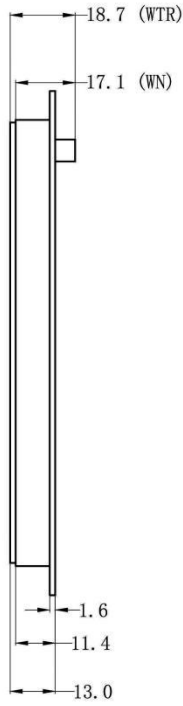

Model	DMG64480K057-03WTR		
Drawing	A 4	Drawn	J. G
Scale	1:1	Review	
Unit	MM	Approval	
		Date	
		Date	230417
DWIN Technologies			

5. Debugging tools

It is recommended for new users of DWIN smart LCMs to purchase official accessories. For more details, please refer to customer service center.

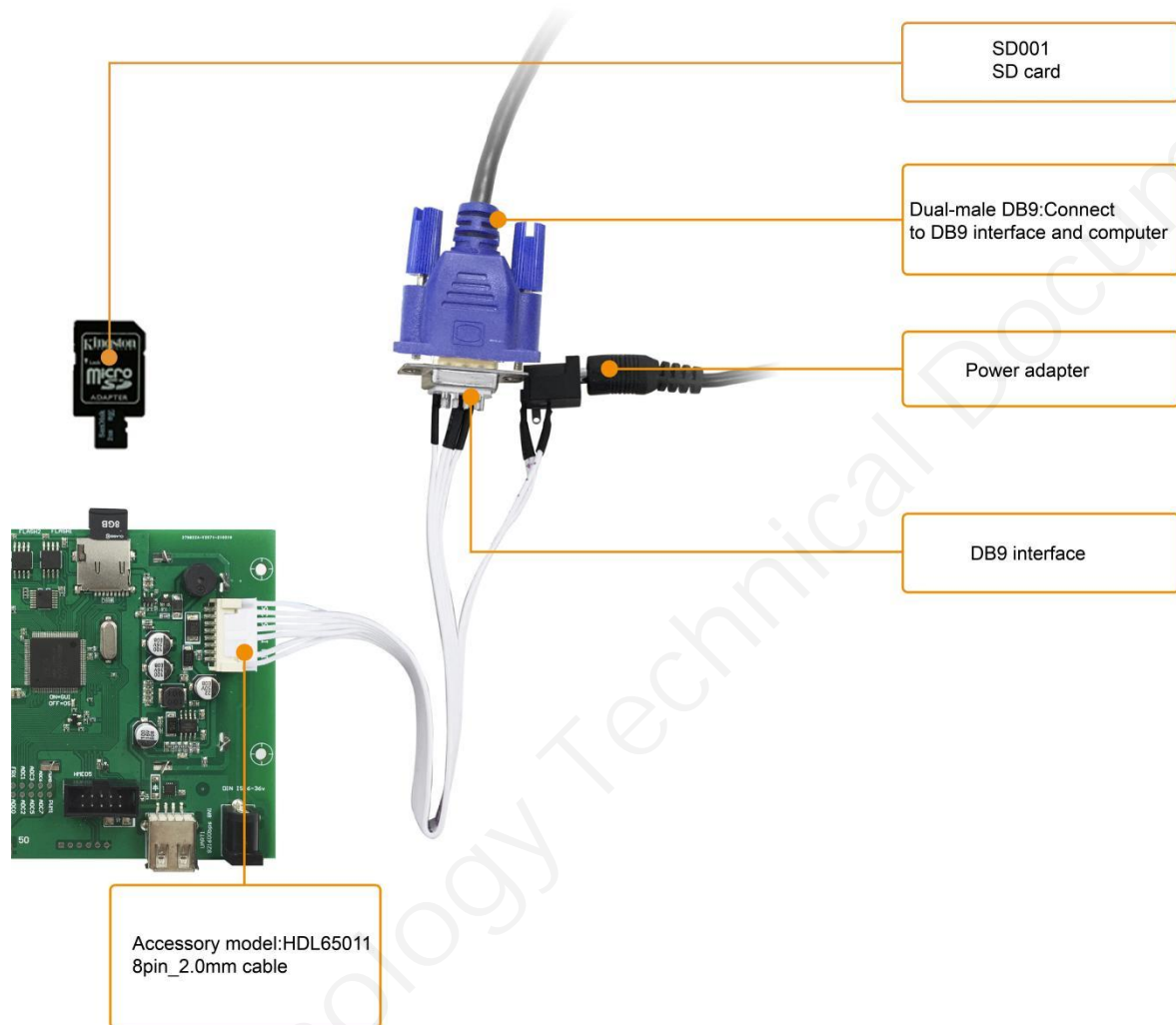

6. T5L series IC features

- (1) Mature and stable 8051 core which is the most widely used with the maximum operating frequency of T5L is up to 250MHz, 1T(single instruction cycle)high speed operation.
- (2) Separate GUI CPU Core running DGUS II System:
 - High-speed display memory, 2.4GB/S bandwidth.
 - 2D hardware acceleration, the decompression speed of JPEG is up to 200fps@1280*800 and the UI with animation and icons as its main feature is extremely cool and smooth.
 - Images and icons stored in JPEG format. Adopt Low-cost 16Mbytes SPI Flash.
 - Support CTP or RTP with adjustable sensitivity and maximum 400 Hz touch frequency.
 - 1-way 15bit 32Ksps PWM digital power amplifier driver loudspeaker, save power amplifier cost and achieve high signal-to-noise ratio and sound quality restoration.
 - 128Kbytes variable storage space for exchanging data with OS CPU Core and memory.
 - Support DGUS development and simulation on PC. Support background remote upgrade.
- (3) Separate CPU (OS CPU) core runs user 8051 code or DWIN OS system and user CPU is omitted in practical application:
 - Standard 8051 architecture and instruction set, 64Kbytes code space, 32Kbytes on-chip RAM.
 - 64 bit integer mathematical operation unit (MDU), including 64 bit MAC and 64 bit divider.
 - 28 IOs, 4-channel UARTs, 1-channel CAN, up to 8-channel 12-bit A/Ds and 2-channle 16-bit PWM of adjustable resolution.
 - Support IAP on-line simulation and debugging with unlimited number of breakpoints.
 - Upgrade code online through DGUS system.
- (4) 1Mbytes on-chip Flash with DWIN patent encryption technology ensure code and data security.
- (5) Operating temperature ranges from -40°C to +85°C(IC operating temperature customizable from -55°C to 105°C).

DWIN encourages users to design your own customized product based on T5L

7. Revision records

Rev	Revise Date	Content	Editor
00	2023-04-26	First Edition	Xu Ying

Please contact us if you have any questions about the use of this document or our products, or if you would like to know the latest information about our products:

- Customer service Tel: +86 400 018 9008
- Customer service email: dwinhmi@dwin.com.cn
- DWIN Developer Forum: <https://forums.dwin-global.com/>

Thank you all for continuous support of DWIN, and your approval is the driving force of our progress!